

Характеристики

Входное давление	Max. 10 bar
Область температур	-10 °C to +50 °C
Рабочие среды	Сжатый воздух
Степень защиты	IP 65
Рабочее давление	0.5 - 8 bar
Размер пор в фильтрующем элементе	20 µm
Измерение расхода воздуха	At 6,3 bar and $\Delta p = 1$ bar
Дополнительная информация	Druckschalter Wechsler

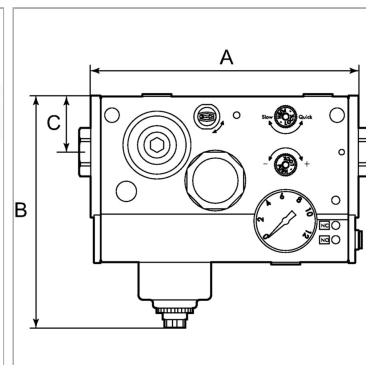

Указания

Прочие данные только по запросу.

Описание

Multifunctional service unit with 6 or 7 functions in a single device: 3/2-way valve (manually operated), filter with automatic drain valve, air ports, pressure regulator, pressure gauge, soft start valve and optional: pressure switch. This combination of extremely good flow rates and a wide range of functions integrated in a single, compact unit saves valuable space and is unmatched by any similar product available in the market! Soft starting independently of the load and easy replacement of the filter cartridge under pressure are just two of the other outstanding features of this amazing device.

Указание по заказу

This unit can also be supplied with many other combinations of functions and port sizes. We will be pleased to make you an offer to match your individual specification on request!

Дополнительная информация

Pressure switches changeover contact

Артикул

Наименование	Расход ном.	A	C	B
K-07251379	2400	165,5	35,0	144,0 mm
K-07251380	3300	165,5	35,0	144,0 mm
K-07251381	4000	165,5	35,0	144,0 mm