

Характеристики

Область температур	-40 °C to +200 °C (depending on the hose quality and diameter)
Диапазон давлений	Max. 25 bar
рекомендуемые шланги	PTFE hose
Материал	нержавеющая сталь 1.4404
Уплотнение	Pure metal

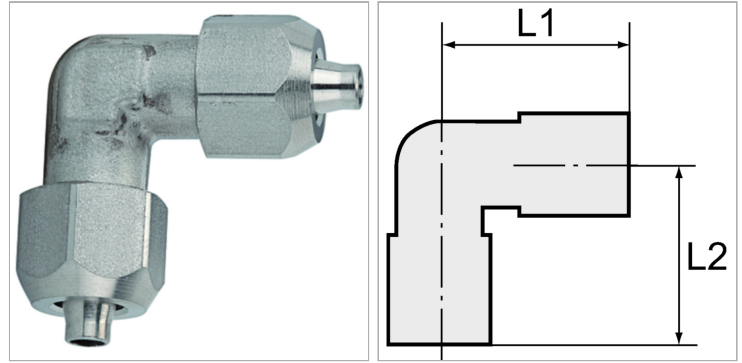

Указания

Прочие данные только по запросу.

Описание

Supplied without seals. For use with corrosive media and at high temperatures. Screw fitting series made of stainless steel for all applications where compliance with strict tightness, pressure and temperature requirements is essential. The parts are manufactured without rubber seals, in other words they are ideal for very high temperatures or for use with corrosive liquids, e.g. in cases when FPM is no longer suitable.

Артикул

Наименование	SW1	SW2	L1	L2
K-07403036	12	10	22,5	22,5
K-07403037	14	10	23,0	23,0
K-07403035	16	10	26,0	26,0