

Характеристики

Модель	Ersatzdichtung für EO-2
Материал	Steel / NBR

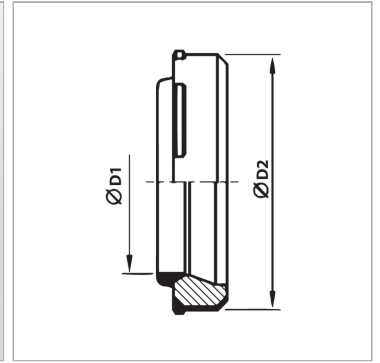

Информация о продукте

$\varnothing d2$	27.7 mm
$\varnothing d1$	20 mm

$\varnothing d1$	20 mm
Серия	S