

Характеристики

Модель	Ersatzdichtung für EO-2
Материал	Steel / NBR

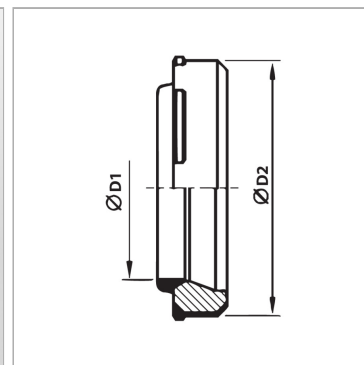

Информация о продукте

$\varnothing d2$	12.3 mm
$\varnothing d1$	6 mm

$\varnothing d1$	6 mm
Серия	L