

Характеристики

Модель	Ersatzdichtung für EO-2
Материал	Steel / NBR

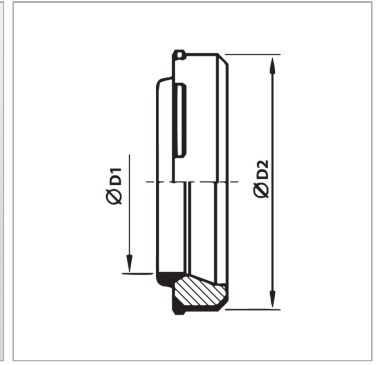

Информация о продукте

$\varnothing d2$	14.3 mm
Серия	S

Серия	S
$\varnothing d1$	8 mm