

### Характеристики

<b>Норма</b>	DIN 7603-A
<b>Материал</b>	Вулканизированная фибра

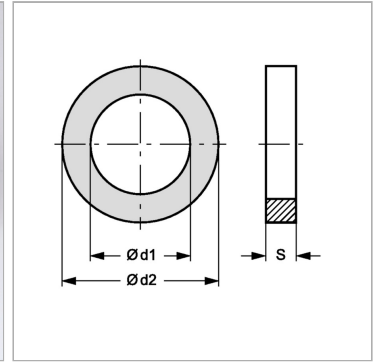

### Информация о продукте

<b>s</b>	2 mm
<b>d1</b>	40 mm

<b>d1</b>	40 mm
<b>d2</b>	47 mm