

Характеристики

Норма	DIN 7603-A
Материал	Вулканизированная фибра

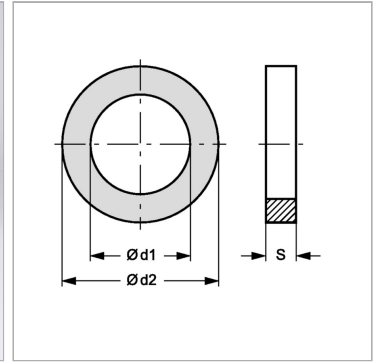

Информация о продукте

s	2 mm
d1	36 mm

d1	36 mm
d2	42 mm