

Характеристики

Норма	DIN 7603-A
Материал	Вулканизированная фибра

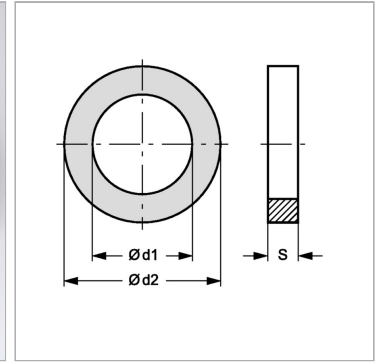

Информация о продукте

s	1 mm
d1	10 mm

d1	10 mm
d2	16 mm