

Характеристики

Модель	Кольцо круглого сечения SAE
Норма	SAE J 518
Материал	NBR SH 90

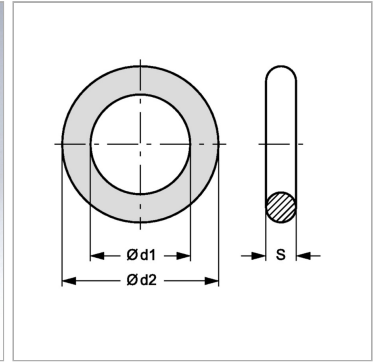

Информация о продукте

$\varnothing d1$	32.92 mm
$\varnothing d2$	39.98 mm

$\varnothing d2$	39.98 mm
S	3.53 mm