

Характеристики

Норма	DIN 74297 Zn
Материал	Цинк

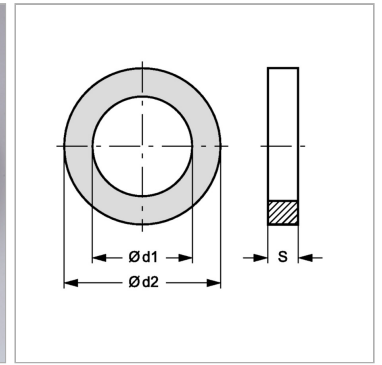

Информация о продукте

$\varnothing d2$	19 mm
$\varnothing d1$	12 mm

$\varnothing d1$	12 mm
S	1.5 mm