

Male connectors, conical male thread, coated with outer hex

Обновлено: 05.04.24

Характеристики

Рабочая температура	-20 °C to +150 °C
Рабочее давление	Max. 16 bar
Материал	Никелированная латунь
Зажимное кольцо	Stainless steel
Прижимное кольцо	Nickel-plated brass

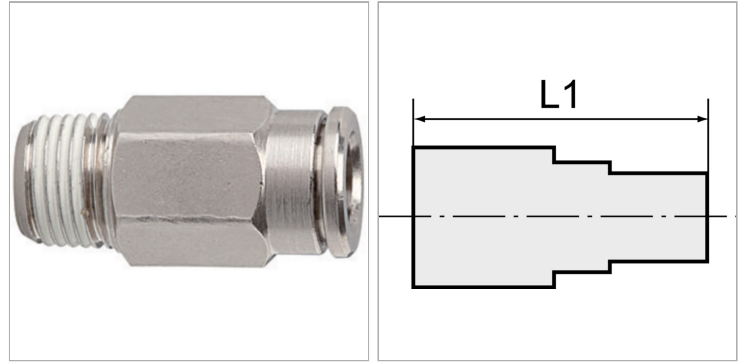

Информация о продукте

Резьба	R 1/4
для наружного Ø шланга	4 mm

L1	22.5 mm
SW	14 mm

Указания

Прочие данные только по запросу.

Описание

Push-in fittings, manufactured entirely in nickel-plated brass. All parts with a parallel thread are supplied with an FPM O-ring.

All parts with conical threads are coated with preCOTE 5 dispersion, all fittings in this series can thus also be used at high temperatures (medium compressed air).