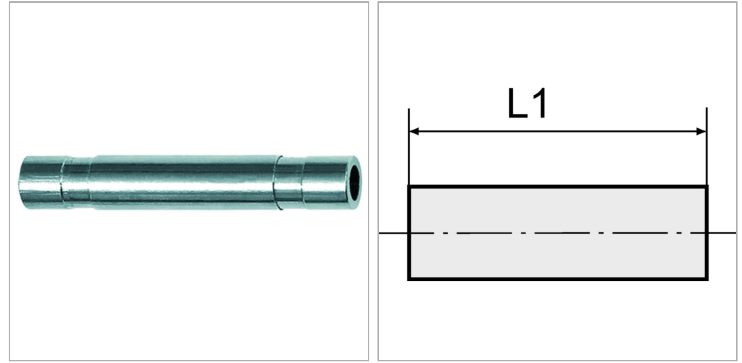

**Характеристики**

<b>Рабочая температура</b>	-20 °C to +80 °C
<b>Рабочее давление</b>	Max. 16 bar
<b>Материал</b>	Никелированная латунь

**Информация о продукте**

для наружного Ø шланга	5 mm
------------------------	------

<b>L1</b>	34 mm
-----------	-------

**Указания**

Прочие данные только по запросу.

**Описание**

The advanced version of our highly successful push-in fittings series manufactured in nickel-plated brass. Advantages of this new, optimised series: Much easier connection and disconnection of the hose, even with repeated mounting, can also be used for non-calibrated hoses, suitable for vacuum operation.