

### Характеристики

**Рабочее давление** Dependent on operating temperature; Max. 10 bar (at 20 °C); Max. 1 bar (at 60 °C)

**Резьбовые детали** Polyamide (PA)

**Гайка** Polypropylene (PP)

**Зажимное кольцо** Polypropylene (PP)

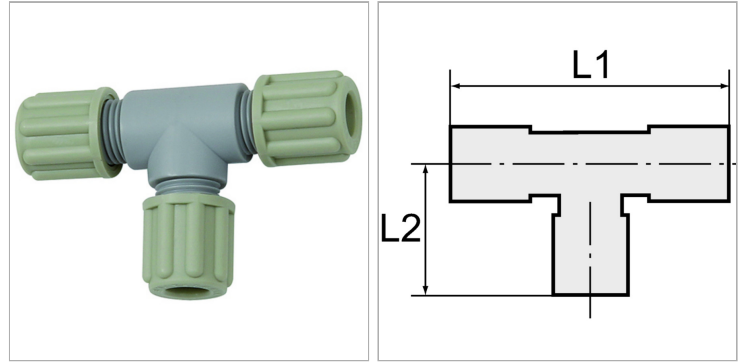

### Информация о продукте

**L2** 31 mm

**L1** 62 mm

**L1** 62 mm

**Для шланга** 6 mm / 8 mm

### Указания

Прочие данные только по запросу.

### Описание

Manufactured from high impact-resistant, UV-stabilised engineering plastic, extremely resistant to weathering. Good chemical resistance to benzene, diesel oil, fuel oil and alkalis.

Not suitable for use with acids.