

Характеристики

Рабочее давление Dependent on operating temperature; Max. 10 bar (at 20 °C); Max. 1 bar (at 60 °C)

Резьбовые детали Polyamide (PA)

Гайка Polypropylene (PP)

Зажимное кольцо Polypropylene (PP)

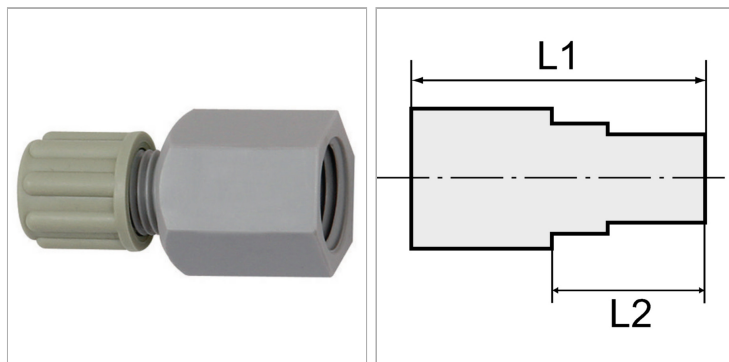

Информация о продукте

Резьба	G 3/8
L2	21 mm
L1	41 mm

L1	41 mm
Для шланга	6 mm / 8 mm
SW	22 mm

Указания

Прочие данные только по запросу.

Описание

Manufactured from high impact-resistant, UV-stabilised engineering plastic, extremely resistant to weathering. Good chemical resistance to benzene, diesel oil, fuel oil and alkalis.

Not suitable for use with acids.