

### Характеристики

**Рабочее давление** Dependent on operating temperature; Max. 10 bar (at 20 °C); Max. 1 bar (at 60 °C)

**Резьбовые детали** Polyamide (PA)

**Гайка** Polypropylene (PP)

**Зажимное кольцо** Polypropylene (PP)

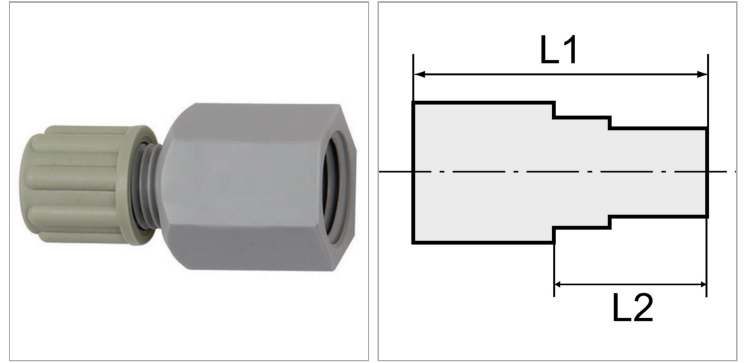

### Информация о продукте

<b>Резьба</b>	G 1/4
<b>L2</b>	21 mm
<b>L1</b>	41 mm

<b>L1</b>	41 mm
<b>Для шланга</b>	6 mm / 8 mm
<b>SW</b>	17 mm

### Указания

Прочие данные только по запросу.

### Описание

Manufactured from high impact-resistant, UV-stabilised engineering plastic, extremely resistant to weathering. Good chemical resistance to benzene, diesel oil, fuel oil and alkalis.

Not suitable for use with acids.