

Male elbows, conical male thread acc. to ISO 7-1, stainless steel

Обновлено: 05.03.24

Характеристики

Область температур	-40 °C to +200 °C (depending on the hose quality and diameter)
Диапазон давлений	Max. 25 bar
рекомендуемые шланги	PTFE hose
Материал	нержавеющая сталь 1.4404
Уплотнение	Pure metal

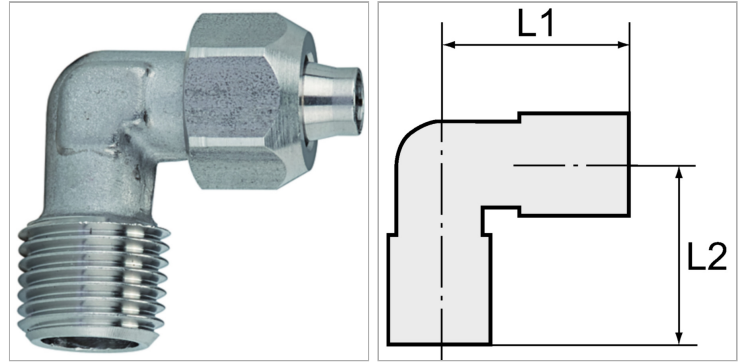

Информация о продукте

Резьба	R 1/4
L2	21.5 mm
SW1	14 mm

L1	23 mm
SW2	10 mm
Для шланга	8 mm / 6 mm

Указания

Прочие данные только по запросу.

Описание

Supplied without seals. For use with corrosive media and at high temperatures. Screw fitting series made of stainless steel for all applications where compliance with strict tightness, pressure and temperature requirements is essential. The parts are manufactured without rubber seals, in other words they are ideal for very high temperatures or for use with corrosive liquids, e.g. in cases when FPM is no longer suitable.