

Характеристики

Рабочая температура	-20 °C to +70 °C
Рабочее давление	Max. 16 bar (at +20 °C)
Материал	Никелированная латунь
Кольцо круглого сечения	NBR, siliconefree
Цанговый зажим	Stainless steel AISI 316
Прижимное кольцо	Hostaform (black nickel-plated for Ø 10, 12)

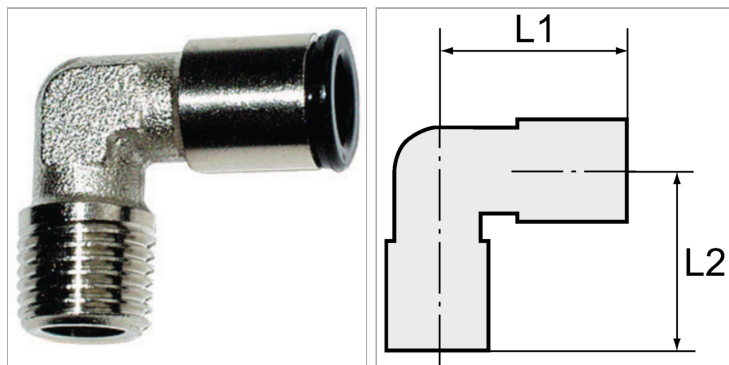

Информация о продукте

Резьба	R 1/8
для наружного Ø шланга	6mm
L2	17.5 mm

L2	17.5 mm
L1	20 mm
SW	10 mm

Указания

Прочие данные только по запросу.

Описание

Economy yet very high-quality series of push-in fittings made of nickel-plated brass. Compact, space-saving, lightweight design. An O-ring in the fillet at the end of the thread guarantees a tight connection for all male thread parts, even on rough surfaces.