

Характеристики

Рабочая температура	-20 °C to +70 °C in air; +1 °C to +70 °C in water
Материал	Acetalpolymerisat (POM)
Уплотнение	Нитрильный каучук
Рабочее давление	0 - 16 bar (4 - 8 mm); 0 - 10 bar (10 - 28 mm)

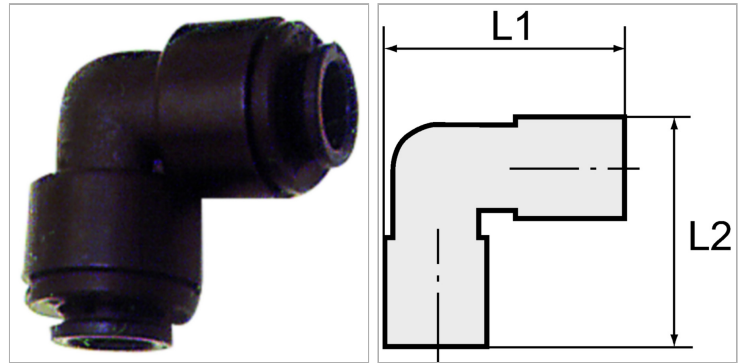

Информация о продукте

для наружного Ø шланга	28 mm
L2	87.7 mm

L2	87.7 mm
L1	87.7 mm

Указания

Прочие данные только по запросу.

Описание

Lightweight, push-in fittings distinguished by high strength, toughness, resistance to abrasion and impact resistance - ideal for a wide range of applications. Plastic and metal tubes are connected together quickly and easily. Suitable for compressed air or liquids, with good resistance to a large number of chemicals.