

### Характеристики

<b>Рабочая температура</b>	-20 °C to +70 °C in air; +1 °C to +70 °C in water
<b>Материал</b>	Acetalpolymerisat (POM)
<b>Уплотнение</b>	Нитрильный каучук
<b>Рабочее давление</b>	0 - 16 bar (4 - 8 mm); 0 - 10 bar (10 - 28 mm)

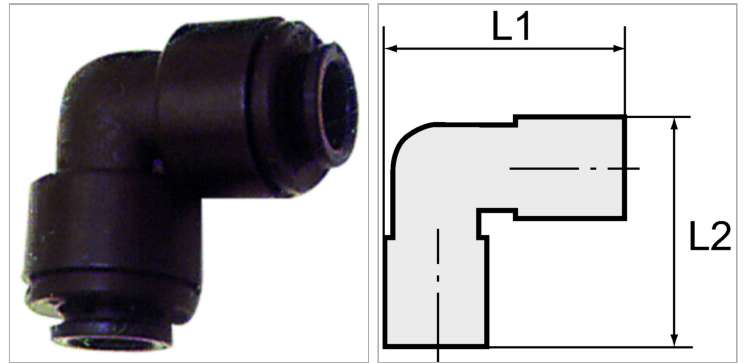

### Информация о продукте

<b>для наружного Ø шланга</b>	22 mm
<b>L2</b>	67.4 mm

<b>L2</b>	67.4 mm
<b>L1</b>	67.4 mm

### Указания

Прочие данные только по запросу.

### Описание

Lightweight, push-in fittings distinguished by high strength, toughness, resistance to abrasion and impact resistance - ideal for a wide range of applications. Plastic and metal tubes are connected together quickly and easily. Suitable for compressed air or liquids, with good resistance to a large number of chemicals.