

Male elbows, swivel type, conical male thread, coated

Обновлено: 04.30.24

Характеристики

Рабочая температура	-20 °C to +150 °C
Рабочее давление	Max. 16 bar
Материал	Никелированная латунь
Зажимное кольцо	Stainless steel
Прижимное кольцо	Nickel-plated brass

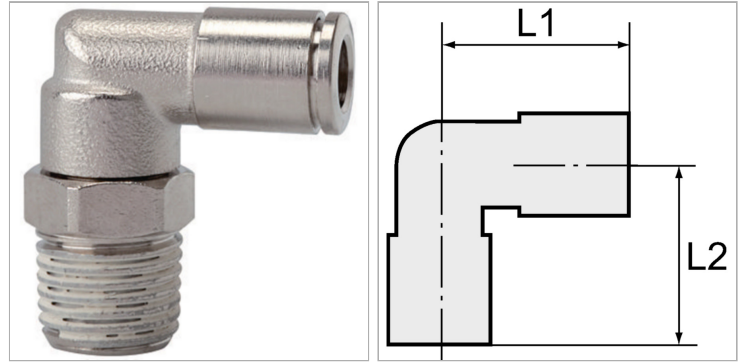

Информация о продукте

Резьба	R 3/8
для наружного Ø шланга	8 mm
L2	28 mm

L2	28 mm
L1	24 mm
SW	18 mm

Указания

Прочие данные только по запросу.

Описание

Push-in fittings, manufactured entirely in nickel-plated brass. All parts with a parallel thread are supplied with an FPM O-ring.

All parts with conical threads are coated with preCOTE 5 dispersion, all fittings in this series can thus also be used at high temperatures (medium compressed air).