

## Male elbows, swivel type, conical male thread, coated

Обновлено: 04.29.24

### Характеристики

<b>Рабочая температура</b>	-20 °C to +150 °C
<b>Рабочее давление</b>	Max. 16 bar
<b>Материал</b>	Никелированная латунь
<b>Зажимное кольцо</b>	Stainless steel
<b>Прижимное кольцо</b>	Nickel-plated brass

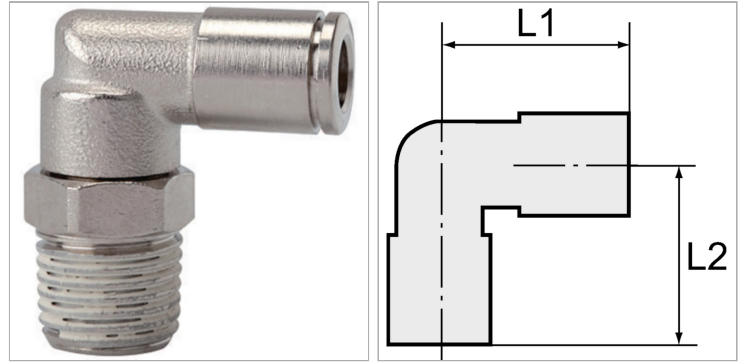

### Информация о продукте

<b>Резьба</b>	R 1/4
<b>для наружного Ø шланга</b>	6mm
<b>L2</b>	25 mm

<b>L2</b>	25 mm
<b>L1</b>	21 mm
<b>SW</b>	14 mm

### Указания

Прочие данные только по запросу.

### Описание

Push-in fittings, manufactured entirely in nickel-plated brass. All parts with a parallel thread are supplied with an FPM O-ring.

All parts with conical threads are coated with preCOTE 5 dispersion, all fittings in this series can thus also be used at high temperatures (medium compressed air).