

### Характеристики

<b>Рабочая температура</b>	-20 °C to +70°C
<b>Рабочее давление</b>	Max. 16 bar
<b>Материал</b>	Никелированная латунь
<b>Зажимное кольцо</b>	Stainless steel
<b>Прижимное кольцо</b>	Hostaform

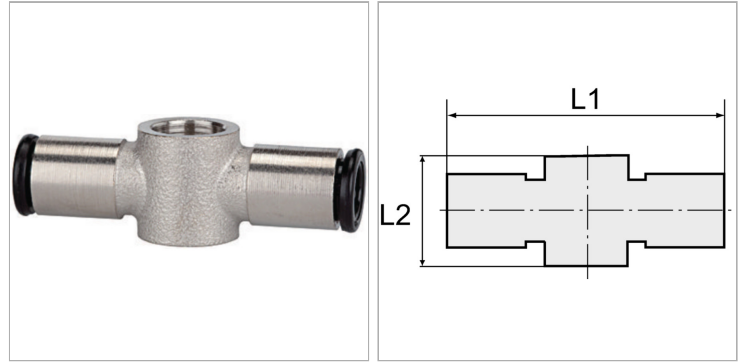

### Информация о продукте

<b>для наружного Ø шланга</b>	12 mm
<b>L2</b>	20 mm

<b>Для полого винта</b>	G 3/8
<b>L1</b>	58 mm

### Указания

Прочие данные только по запросу.

### Описание

The advanced version of our highly successful push-in fittings series manufactured in nickel-plated brass. Advantages of this new, optimised series: Much easier connection and disconnection of the hose, even with repeated mounting, can also be used for non-calibrated hoses, suitable for vacuum operation.