

### Характеристики

|                            |                       |
|----------------------------|-----------------------|
| <b>Рабочая температура</b> | -20 °C to +70°C       |
| <b>Рабочее давление</b>    | Max. 16 bar           |
| <b>Материал</b>            | Никелированная латунь |
| <b>Зажимное кольцо</b>     | Stainless steel       |
| <b>Прижимное кольцо</b>    | Hostaform             |

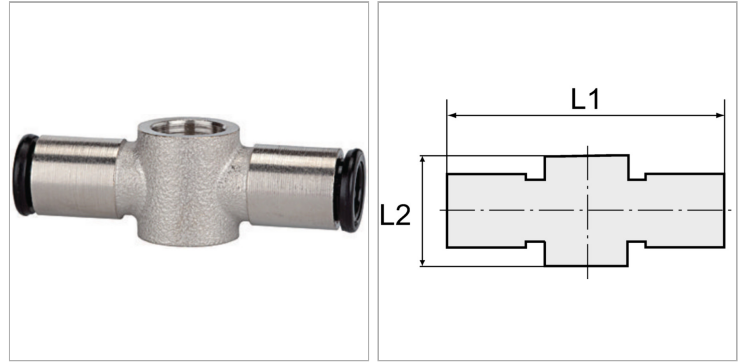

### Информация о продукте

|                               |       |
|-------------------------------|-------|
| <b>для наружного Ø шланга</b> | 8 mm  |
| <b>L2</b>                     | 15 mm |

|                         |       |
|-------------------------|-------|
| <b>Для полого винта</b> | G 1/8 |
| <b>L1</b>               | 49 mm |

### Указания

Прочие данные только по запросу.

### Описание

The advanced version of our highly successful push-in fittings series manufactured in nickel-plated brass. Advantages of this new, optimised series: Much easier connection and disconnection of the hose, even with repeated mounting, can also be used for non-calibrated hoses, suitable for vacuum operation.