

Характеристики

Рабочая температура	-20 °C to +70°C
Рабочее давление	Max. 16 bar
Материал	Никелированная латунь
Зажимное кольцо	Stainless steel
Прижимное кольцо	Hostaform

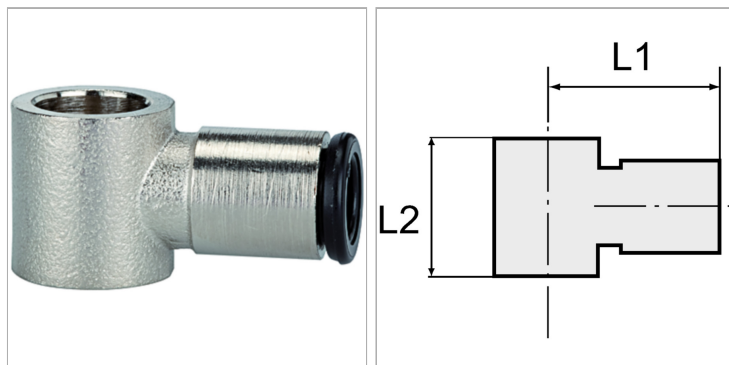

Информация о продукте

для наружного Ø шланга	6mm	Для полого винта	G 1/8
L2	15 mm	L1	23 mm

Указания

Прочие данные только по запросу.

Описание

The advanced version of our highly successful push-in fittings series manufactured in nickel-plated brass. Advantages of this new, optimised series: Much easier connection and disconnection of the hose, even with repeated mounting, can also be used for non-calibrated hoses, suitable for vacuum operation.