

Male elbows, swivel type, parallel male thread with O-ring

Обновлено: 05.06.24

Характеристики

Рабочая температура	-20 °C to +80 °C
Рабочее давление	Max. 16 bar
Материал	Никелированная латунь
Кольцо круглого сечения	NBR
Зажимное кольцо	Stainless steel
Прижимное кольцо	Hostaform

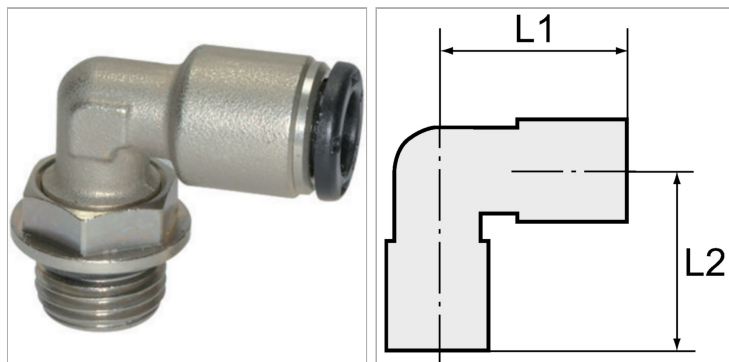

Информация о продукте

Резьба	G 1/8
для наружного Ø шланга	5 mm
L2	19.1 mm

L2	19.1 mm
L1	22.8 mm
SW	12 mm

Указания

Прочие данные только по запросу.

Описание

The advanced version of our highly successful push-in fittings series manufactured in nickel-plated brass. Advantages of this new, optimised series: Much easier connection and disconnection of the hose, even with repeated mounting, can also be used for non-calibrated hoses, suitable for vacuum operation.