

Male connectors, parallel male thread with O-ring and outer hex

Обновлено: 05.01.24

Характеристики

Рабочая температура	-20 °C to +80 °C
Рабочее давление	Max. 16 bar
Материал	Никелированная латунь
Кольцо круглого сечения	NBR
Зажимное кольцо	Stainless steel
Прижимное кольцо	Hostaform

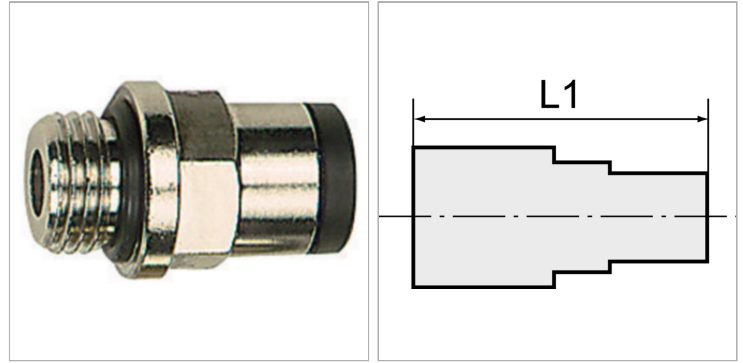

Информация о продукте

Резьба	G 3/8
для наружного Ø шланга	12 mm
Внутренний шестигранник	10 mm

Внутренний шестигранник	10 mm
L1	28.1 mm
SW	19 mm

Указания

Прочие данные только по запросу.

Описание

The advanced version of our highly successful push-in fittings series manufactured in nickel-plated brass. Advantages of this new, optimised series: Much easier connection and disconnection of the hose, even with repeated mounting, can also be used for non-calibrated hoses, suitable for vacuum operation.