

### Характеристики

Область температур -40 °C to +90 °C

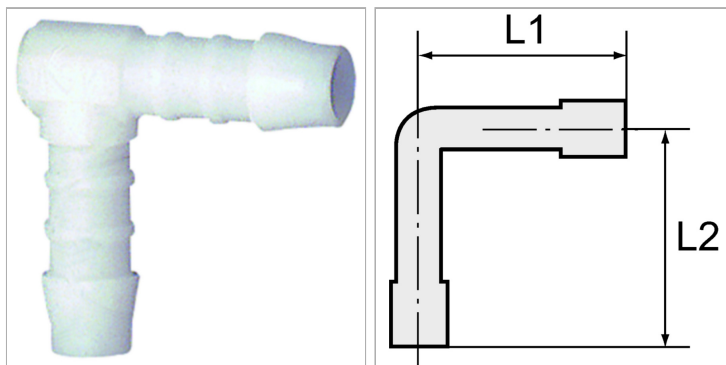

### Информация о продукте

**L2** 38.5 mm

макс. допустимое избыточное давление 10 bar

**L1** 36.5 mm

Для шланга LW 13 mm

### Указания

Прочие данные только по запросу.

### Описание

Lightweight tube connectors distinguished by high strength, toughness, resistance to abrasion and impact resistance. Resistant to: Acetone, benzene, butane, alcohols, diesel fuels, crude oil, natural gas, ethanol, fruit juices, glycerine, fuel oil, hydraulic fluids, aliphatic ketones, carbon dioxide, carbonic acid, engine oils, methanol, propane, liquefied gas, lubricating oils, lubricating greases, town gas, washing liquor and water.