

Male stud tees, polyamide, conical male thread acc. to ISO 7-1

Обновлено: 05.02.24

Характеристики

Область температур	-40 °C to +90 °C
--------------------	------------------

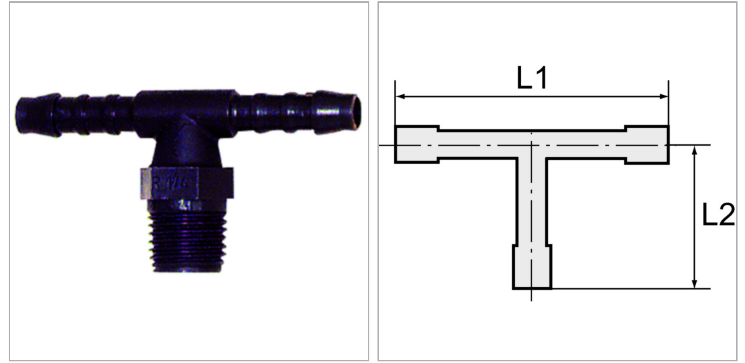

Информация о продукте

Резьба	R 1/8	L1	42 mm
L2	18 mm	Для шланга	LW 4 mm
макс. допустимое избыточное давление	10 bar	SW	10 mm

Указания

Прочие данные только по запросу.

Описание

Lightweight tube connectors distinguished by high strength, toughness, resistance to abrasion and impact resistance. Resistant to: Acetone, benzene, butane, alcohols, diesel fuels, crude oil, natural gas, ethanol, fruit juices, glycerine, fuel oil, hydraulic fluids, aliphatic ketones, carbon dioxide, carbonic acid, engine oils, methanol, propane, liquefied gas, lubricating oils, lubricating greases, town gas, washing liquor and water.