

Unidirectional flow control valves with parallel male thread and plug connection, straight type, air restriction from tube to port

Характеристики

Рабочее давление	Max. 15 bar, coarse vacuum
Область температур	-20 °C to +80 °C
Рабочие среды	Compressed air and all gases or liquids that are compatible with the materials
рекомендуемые шланги	PU or PA (nylon)
Область применения	Air, vacuum
Уплотнительная поверхность	Parallel version: O-ring in housing, Conical version: thread coating
Материал	Plastic, Nickel plated brass
Прижимное кольцо	Plastic

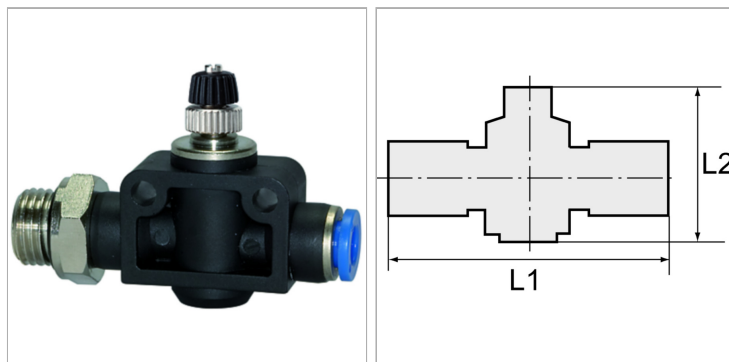

Информация о продукте

Резьба	G 1/4	L2 мин.	47.4 mm
для наружного Ø шланга	10 mm	L2 макс.	54 mm
L1	70.3 mm	SW	17 mm

Указания

Прочие данные только по запросу.

Описание

Push-in fittings series manufactured in plastic and nickel-plated brass. All parts are suitable for use with hoses, tubes or pipes made of plastic and copper.