

## Male branch tees, swivel type, parallel male thread with O-ring

Обновлено: 04.29.24

### Характеристики

<b>Рабочее давление</b>	Max. 15 bar, coarse vacuum
<b>Область температур</b>	-20 °C to +80 °C
<b>Рабочие среды</b>	Compressed air and all gases or liquids that are compatible with the materials
<b>рекомендуемые шланги</b>	PU or PA (nylon)
<b>Область применения</b>	Air, vacuum
<b>Уплотнительная поверхность</b>	Parallel version: O-ring in housing
<b>Материал</b>	Plastic, Nickel plated brass
<b>Прижимное кольцо</b>	Plastic

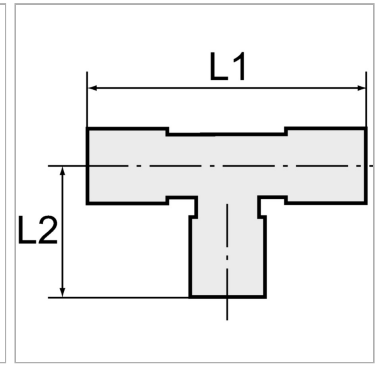

### Информация о продукте

<b>Резьба</b>	G 1/4
<b>для наружного Ø шланга</b>	8 mm
<b>L2</b>	21.7 mm

<b>L2</b>	21.7 mm
<b>L1</b>	45.4 mm
<b>SW</b>	17 mm

### Указания

Прочие данные только по запросу.

### Описание

Push-in fittings series manufactured in plastic and nickel-plated brass. All parts are suitable for use with hoses, tubes or pipes made of plastic and copper.