

Male branch tees, swivel type, parallel male thread with O-ring

Обновлено: 04.28.24

Характеристики

Рабочее давление	Max. 15 bar, coarse vacuum
Область температур	-20 °C to +80 °C
Рабочие среды	Compressed air and all gases or liquids that are compatible with the materials
рекомендуемые шланги	PU or PA (nylon)
Область применения	Air, vacuum
Уплотнительная поверхность	Parallel version: O-ring in housing
Материал	Plastic, Nickel plated brass
Прижимное кольцо	Plastic

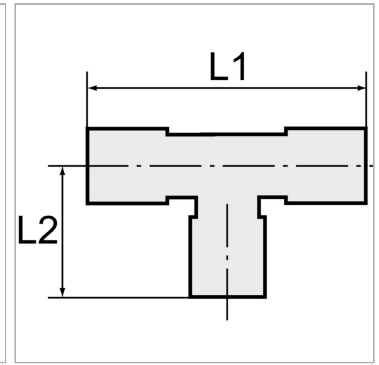
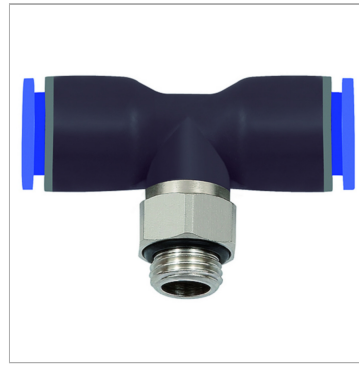

Информация о продукте

Резьба	M 5
для наружного Ø шланга	6mm
L2	22.2 mm

L2	22.2 mm
L1	40 mm
SW	8 mm

Указания

Прочие данные только по запросу.

Описание

Push-in fittings series manufactured in plastic and nickel-plated brass. All parts are suitable for use with hoses, tubes or pipes made of plastic and copper.