

Female connectors, parallel female thread with outer hex

Обновлено: 05.03.24

Характеристики

Рабочее давление	Max. 15 bar, coarse vacuum
Область температур	-20 °C to +80 °C
Рабочие среды	Compressed air and all gases or liquids that are compatible with the materials
рекомендуемые шланги	PU or PA (nylon)
Область применения	Air, vacuum
Материал	Plastic, Nickel plated brass
Прижимное кольцо	Plastic

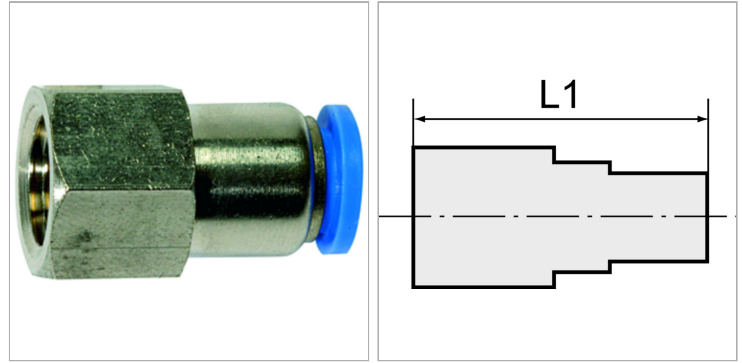

Информация о продукте

Резьба	G 1/8	L1	27.1 mm
для наружного Ø шланга	8 mm	SW	14 mm

Указания

Прочие данные только по запросу.

Описание

Push-in fittings series manufactured in plastic and nickel-plated brass. All parts are suitable for use with hoses, tubes or pipes made of plastic and copper.