

Характеристики

Рабочая температура	-20 °C to +170 °C
Резьба, описание	Rp thread acc. to ISO 7-1
Шар	hardchrome-plated brass
Корпус	Nickel-plated brass
Пружина	Stainless steel 1.4301
Уплотнение шара	PTFE
Уплотнение шпинделя	FKM
Рукоятка	Steel - PVC coated

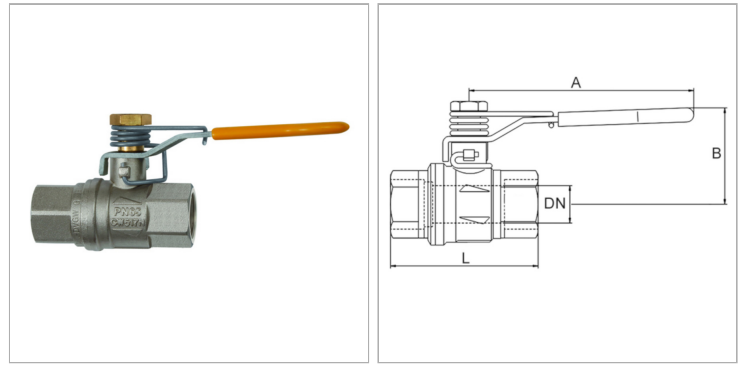

Информация о продукте

DN	8
Резьба	Rp 1/4
PN (бар)	65

B	40 mm
A	100 mm
L	50 mm

DN = номинальный диаметр, номинальный внутренний диаметр

Указания

Прочие данные только по запросу.

Описание

2/2-way safety ball valves, two parts, made of nickel-plated brass with spring return. Applications: Compressed air, water, oils, fuel oil, fuels, inert gases. Silicone-free. The ball valve is closed in the normal position and opens against spring force.

Указание по заказу

For use on devices that have to be vented whenever they are turned off, either because of safety regulations or for technical reasons. The pneumatic devices are disconnected from the system and simultaneously vented each time they are shut off.