

### Характеристики

<b>Уплотнение</b>	FKM
<b>Рабочая температура</b>	-10 °C to +200 °C
<b>Рабочее давление</b>	0,2 - 26 bar
<b>Резьба наружная</b>	G 1/2", G 3/4", G 1", G 1 1/4", G 1 1/2", G 2".
<b>Корпус</b>	Brass
<b>Нажимная пружина</b>	C steel
<b>Дополнительная информация</b>	Wichtiger Hinweis: Diese Ventile sind baumustergeprüft und dürfen nur fest eingestellt ausgeliefert werden.

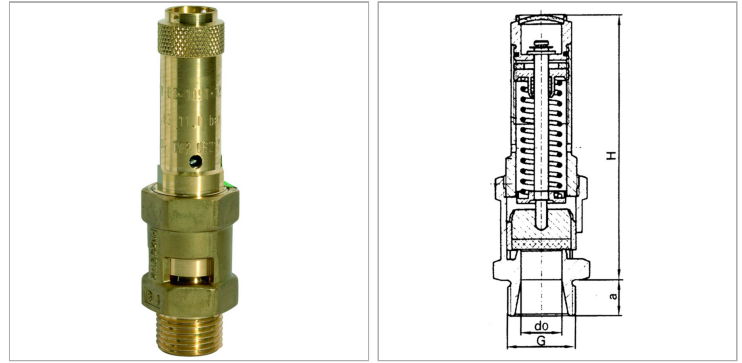

### Информация о продукте

<b>Резьба</b>	G 2"
<b>Давление реагирования</b>	8.0 bar
<b>SW</b>	70 mm

<b>a</b>	25 mm
<b>do</b>	40 mm
<b>H</b>	203 mm

### Указания

Прочие данные только по запросу. G thread acc. to DIN EN ISO 228-1, with ISO flange plate (acc. to ISO 5211)

### Описание

For compressed air and non-toxic, non-flammable gases, cannot be used for liquids due to free blow-off, not suitable for steam. These valves are TÜV approved and have a TÜV type test number.

### Указание по заказу

For full order codes with the desired operating pressure, please visit our online catalogue or on request.

### Дополнительная информация

Important information: These valves are type-tested and are only allowed to be delivered with a fixed setting.