

Характеристики

Уплотнение	FKM
Рабочая температура	-10 °C to +200 °C
Рабочее давление	0,2 - 26 bar
Резьба наружная	G 1/2", G 3/4", G 1", G 1 1/4", G 1 1/2", G 2".
Корпус	Brass
Нажимная пружина	C steel
Дополнительная информация	Wichtiger Hinweis: Diese Ventile sind baumustergeprüft und dürfen nur fest eingestellt ausgeliefert werden.

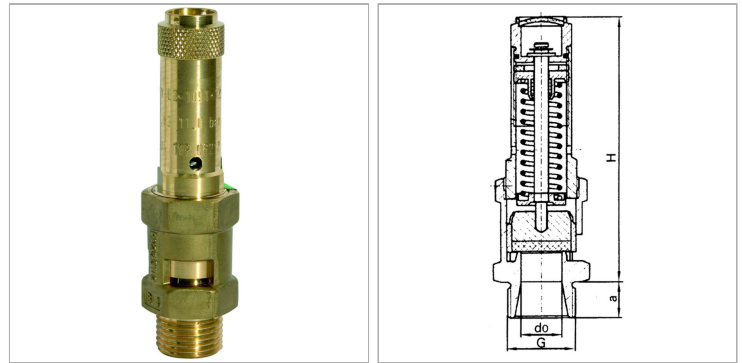

Информация о продукте

Резьба	G 1"
Давление реагирования	1.2 bar
SW	41 mm

a	18 mm
do	20 mm
H	132 mm

Указания

Прочие данные только по запросу. G thread acc. to DIN EN ISO 228-1, with ISO flange plate (acc. to ISO 5211)

Описание

For compressed air and non-toxic, non-flammable gases, cannot be used for liquids due to free blow-off, not suitable for steam. These valves are TÜV approved and have a TÜV type test number.

Указание по заказу

For full order codes with the desired operating pressure, please visit our online catalogue or on request.

Дополнительная информация

Important information: These valves are type-tested and are only allowed to be delivered with a fixed setting.