

### Характеристики

|                                  |   |
|----------------------------------|---|
| <b>Уплотнение</b>                | FKM   |
| <b>Рабочая температура</b>       | -10 °C to +200 °C   |
| <b>Рабочее давление</b>          | 0,2 - 26 bar  |
| <b>Резьба наружная</b>           | G 1/2", G 3/4", G 1", G 1 1/4", G 1 1/2", G 2".   |
| <b>Корпус</b>                    | Brass   |
| <b>Нажимная пружина</b>          | C steel   |
| <b>Дополнительная информация</b> | Wichtiger Hinweis: Diese Ventile sind baumustergeprüft und dürfen nur fest eingestellt ausgeliefert werden. |

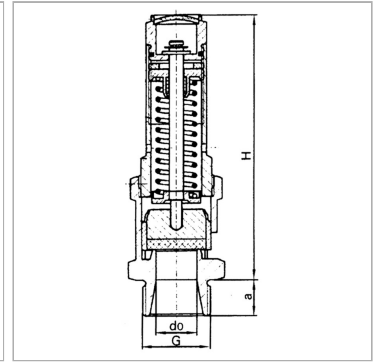

### Информация о продукте

|                              |         |
|------------------------------|---------|
| <b>Резьба</b>                | G 3/4"  |
| <b>Давление реагирования</b> | 4.5 bar |
| <b>SW</b>                    | 32 mm   |

|           |        |
|-----------|--------|
| <b>a</b>  | 16 mm  |
| <b>do</b> | 15 mm  |
| <b>H</b>  | 110 mm |

### Указания

Прочие данные только по запросу. G thread acc. to DIN EN ISO 228-1, with ISO flange plate (acc. to ISO 5211)

### Описание

For compressed air and non-toxic, non-flammable gases, cannot be used for liquids due to free blow-off, not suitable for steam. These valves are TÜV approved and have a TÜV type test number.

### Указание по заказу

For full order codes with the desired operating pressure, please visit our online catalogue or on request.

### Дополнительная информация

Important information: These valves are type-tested and are only allowed to be delivered with a fixed setting.