

Характеристики

Температура	-40 ° C up to max. +170 ° C; Warning: The freezing fluid in the system may damage the valve difficult
Резьба, описание	Rp thread acc. to EN 10226
Корпус	Nickel-plated brass
Уплотнение шара	PTFE
Уплотнение шпинделя	PTFE (политетрафторэтилен)
Рукоятка	Steel - PVC coated
Дополнительная информация	Vorhängeschloss nicht im Preis inbegriffen. Bitte separat bestellen.

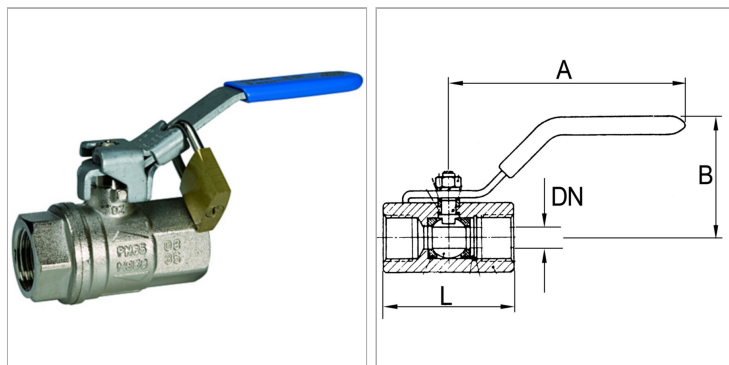

Информация о продукте

DN	40
Резьба	Rp 1 1/2
PN (бар)	30

B	85 mm
A	158 mm
L	117 mm

DN = номинальный диаметр, номинальный внутренний диаметр

Указания

Прочие данные только по запросу. G thread acc. to DIN EN ISO 228-1, with ISO flange plate (acc. to ISO 5211)

Описание

2/2-way safety ball valves made of nickel-plated brass. Specially designed for pneumatic applications. The ball valve can be locked manually. Full bore, heavy-duty type.

Указание по заказу

For use on devices that have to be vented whenever they are turned off, either because of safety regulations or for technical reasons. The pneumatic devices are disconnected from the system and simultaneously vented each time they are shut off.

Дополнительная информация

The price does not include a padlock. Please order separately.