

Характеристики

Рабочая температура	0 °C to +60 °C
Уплотнение	PTFE
Резьба, описание	Rp thread acc. to ISO 7-1
Корпус, шар, шпindelь, сальник	Nickel-plated brass
Рукоятка	Die-cast aluminium, black
Материал	sealing: PTFE

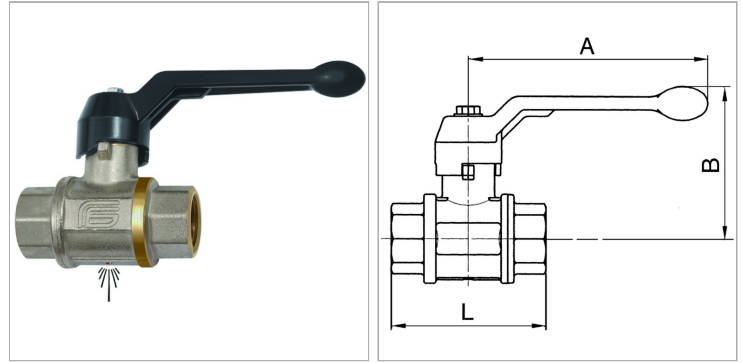

Информация о продукте

DN	8
Резьба	Rp 1/4
макс. рабочее давление при 20°C	12 bar

B	61 mm
A	100 mm
L	52 mm

DN = номинальный диаметр, номинальный внутренний диаметр

Указания

Прочие данные только по запросу.

Описание

2/2-way brass safety ball valves. Specially designed for pneumatic applications. The ball valve shuts off the supply side and relieves the application into the atmosphere.

Указание по заказу

For use on devices that have to be vented whenever they are turned off, either because of safety regulations or for technical reasons. The pneumatic devices are disconnected from the system and simultaneously vented each time they are shut off.