

Характеристики

Рабочая температура	max. +70 °C
Рабочее давление	макс. 10 бар

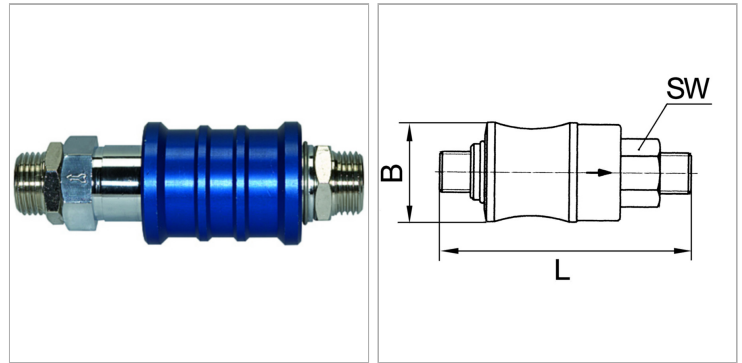

Информация о продукте

Резьба	G 3/8	B	31 mm
SW	22 mm	L	87 mm

Указания

Прочие данные только по запросу.

Описание

For use on devices that have to be vented whenever they are turned off, either because of safety regulations or for technical reasons. The pneumatic devices are disconnected from the system and simultaneously vented each time they are shut off.