

Характеристики

Отверстие	L-образная форма
Рабочая температура	max. 160 °C
Рабочее давление	max. 63 bar
Ориентировочные значения	Up to 40 °C: 63 bar, 150 °C: 28 bar
Уплотнение	RTFE
Рукоятка	Stainless steel
Шаровой кран	Stainless steel 1.4408
Дополнительная информация	G-Gewinde nach DIN EN ISO 228-1

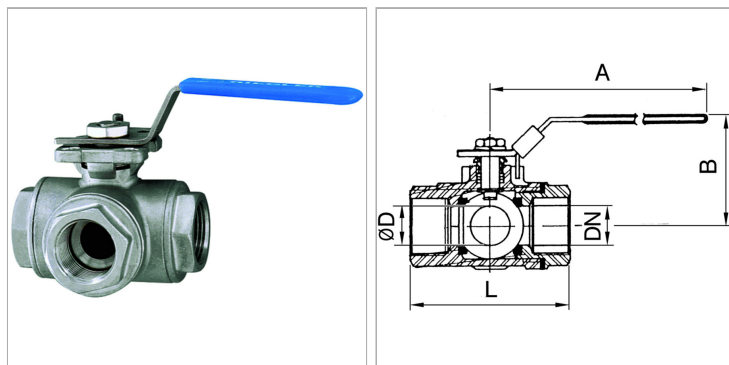

Информация о продукте

DN	8
Резьба	G 1/4
B	73 mm

Ø D	11 mm
A	114 mm
L	80 mm

DN = номинальный диаметр, номинальный внутренний диаметр

Указания

Прочие данные только по запросу. G thread acc. to DIN EN ISO 228-1, with ISO flange plate (acc. to ISO 5211)

Описание

With L-bore, reduced bore. Version for sealing on all sides with integrated ISO flange plate (ISO 5211). The lever can be turned 360° to allow several switching variants.

Указание по заказу

For use on devices that have to be vented whenever they are turned off, either because of safety regulations or for technical reasons. The pneumatic devices are disconnected from the system and simultaneously vented each time they are shut off.

Дополнительная информация

G thread acc. DIN EN ISO 228-1