

### Характеристики

<b>Рабочая температура</b>	-15 °C to +100 °C
<b>Рабочее давление</b>	Max. 40 bar
<b>Резьба, описание</b>	G thread acc. DIN EN ISO 228-1
<b>Шар</b>	Chrome-plated brass
<b>Корпус</b>	Nickel-plated brass (outside); Brass with a bare metal surface (inside)
<b>Уплотнение шара</b>	PTFE
<b>маховик</b>	Plastic
<b>Уплотнение шпинделя</b>	Нитрильный каучук

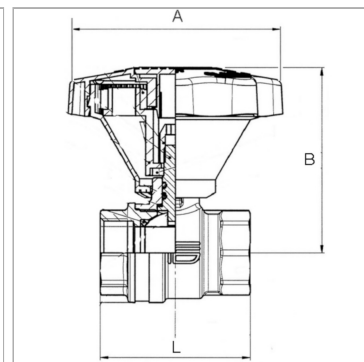

### Информация о продукте

<b>DN</b>	25
<b>Резьба</b>	G 1
<b>B</b>	80 mm

<b>B</b>	80 mm
<b>A</b>	83 mm
<b>L</b>	68.8 mm

DN = номинальный диаметр, номинальный внутренний диаметр

### Указания

Прочие данные только по запросу.

### Описание

Brass ball valves in the standard series with fine adjustment. Unlike our classic standard ball valves (open-close function), this model features a special stem technology that allows finely modulated opening and closing of the line.

The flow rate can be regulated extremely precisely as a result. The cock is made of low-lead brass with a bare brass surface on the inside.

It is thus safe to use with drinking water.

This valve complies with the European standard EN 13828 and the working paper DVGW W 570.