

Характеристики

Уплотнение Нитрильный каучук

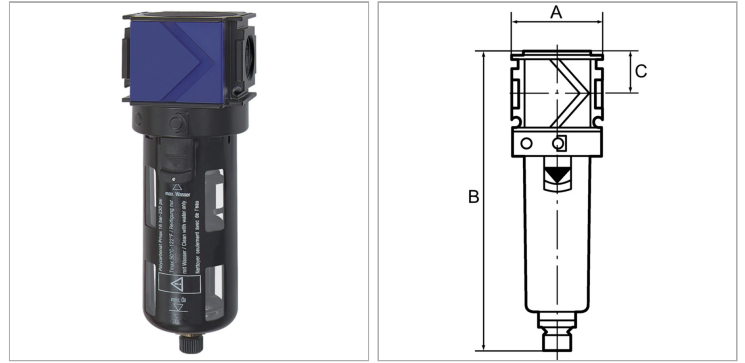

Информация о продукте

Расход ном. 1800 l/min

Расход ном. 1800 l/min

Указания

Прочие данные только по запросу.

Описание

Centrifugal separators with a sintered filter element. Filtration takes place in a 2-stage process comprising cyclone separation (condensate) and a PE filter element (particles).

Approved series in modern industrial design, with the following key benefits: Simple handling, Convenient modular assembly thanks to innovative fasteners, Excellent flow values.

Указание по заказу

Filters are also available with bowl guard or metal bowl.