

Oil-mist lubricators with polycarbonate bowl and bowl guard

Обновлено: 04.19.24

Характеристики

Уплотнение Нитрильный каучук

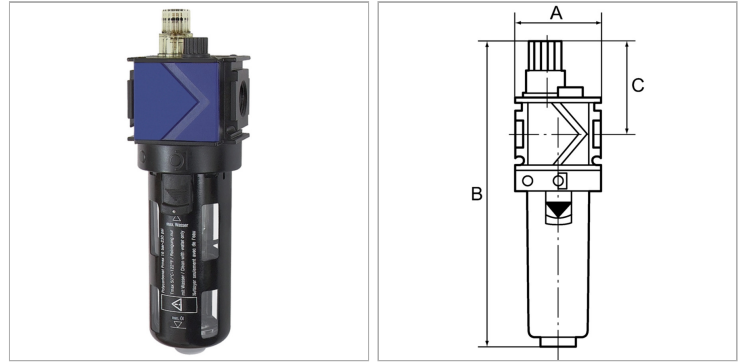

Информация о продукте

Расход ном. 4400 l/min

Расход ном. 4400 l/min

Указания

Прочие данные только по запросу.

Описание

Proportional lubricators, oil can be filled under pressure. Approved series in modern industrial design, with the following key benefits: Simple handling, Convenient modular assembly thanks to innovative fasteners, Excellent flow values.

Указание по заказу

Oil-mist lubricators are also available with bowl guard or metal bowl.