

Service units, 3-piece with polycarbonate bowl and bowl guard

Обновлено: 05.06.24

Характеристики

Уплотнение	Нитрильный каучук
------------	-------------------

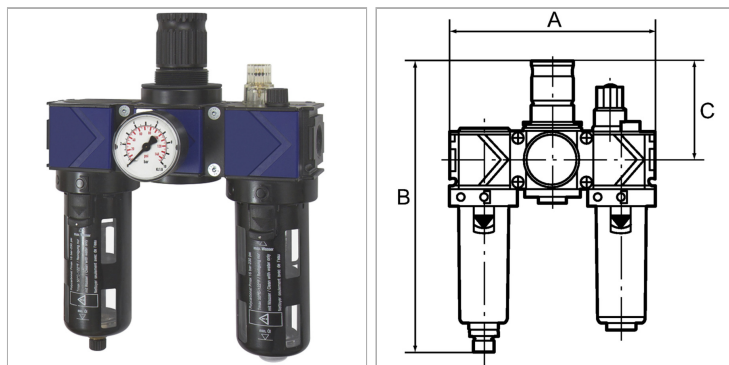

Информация о продукте

Расход ном.	1500 l/min
-------------	------------

Расход ном.	1500 l/min
-------------	------------

Указания

Прочие данные только по запросу.

Описание

Two or three-piece service units consisting of a reversible diaphragm pressure regulator, independent of inlet pressure, with self-relieving design, combined with a centrifugal separator and a proportional lubricator. Approved series in modern industrial design, with the following key benefits: Simple handling, Convenient modular assembly thanks to innovative fasteners, Excellent flow values.

Указание по заказу

Service units are also available with bowl guard or metal bowl. Service units are also available in other control ranges (0.5 - 6 bar and 0.5 - 16 bar) and in lockable version. Please ask for more information.

Дополнительная информация

Service units are also available with bowl guard or metal bowl. Service units are also available in other control ranges.