

SAFETY service unit sets, comprising a ball valve with silencer, start-up valve and filter regulator

Характеристики

Входное давление	2.5 - 16 bar
Выходное давление	0.5 - 8 bar
Область температур	-10 °C to +50 °C
Рабочие среды	Сжатый воздух
Уплотнение	Нитрильный каучук
Мембрана	NBR
Фильтрующий элемент	Cellpor (PE) 5 µm
Соединительная резьба	Material: Die-cast zinc
Емкость	Polycarbonate (with bayonet lock) and bowl guard
Корпус	Material: Grivory® (PA 66)
Расход собственного воздуха	Max. 1.5 l/min (depending on secondary pressure)
Измерение расхода воздуха	At P1 = 10 bar, P2 = 6.3 bar and pressure drop $\Delta p = 1$ bar
Соединение вентиляции	Silencer
Шаровой кран	

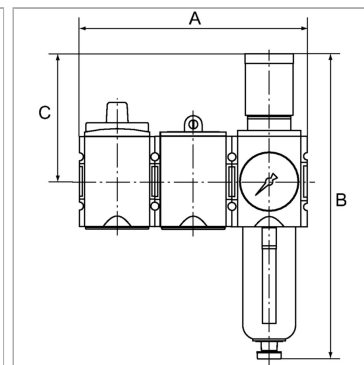

Информация о продукте

Резьба	G 3/8
Расход пот.	2000 l/min
C	95.5 mm

A	156 mm
B	243,0 mm
Отвод конденсата	Auto

Указания

Прочие данные только по запросу.

Описание

These compressed air service unit sets, comprising a ball valve with silencer, a start-up valve and one out of a pressure regulator, filter regulator or service unit, meet even the strictest requirements for operating reliability and accident prevention!

Указание по заказу

The price does not include a key lock and padlock. Please order separately. For accessories and spare parts, refer to individual components: ball valve, start-up valve, pressure regulator, filter regulator, 2-piece service unit