

SAFETY service unit sets, comprising a ball valve with silencer, start-up valve and 2-piece service unit with lock cylinder

Характеристики

Входное давление	2 - 16 bar
Выходное давление	0.5 - 10 bar
Область температур	Max. 60 °C
Рабочие среды	Сжатый воздух
Уплотнение	Нитрильный каучук
Фильтрующий элемент	Cellpor (PE) 5 µm
Корпус	Die-cast zinc
Мембрана	NBR
Емкость	Polycarbonate (with bayonet lock) and bowl guard
Пружинная крышка	POM
Drain valve	Semi-automatic
Измерение расхода воздуха	At P1 = 8 bar, P2 = 6 bar and pressure drop $\Delta p = 1$ bar
Дополнительная информация	siehe Datenblätter der einzelnen Komponenten (auf Anfrage)
Соединение вентиляции	Silencer
Шаровой кран	

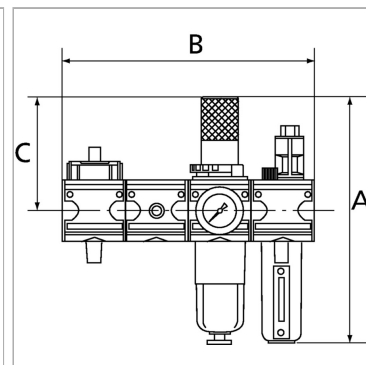
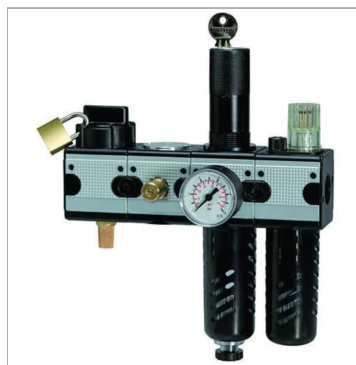

Информация о продукте

Резьба	G 1/4
Расход пот.	1000 l/min
C	94 mm

A	219.1 mm
B	182,8 mm
Отвод конденсата	Semi-automatic

Описание

These compressed air service unit sets, comprising a ball valve with silencer, a start-up valve and one out of a pressure regulator, filter regulator or service unit, meet even the strictest requirements for operating reliability and accident prevention!

Указание по заказу

The price does not include a padlock. Please order separately. For accessories and spare parts, refer to individual components: ball valve, start-up valve, pressure regulator, filter regulator, 2-piece service unit.

Дополнительная информация

see data sheets of the individual components (on request)