

Характеристики

Входное давление	Max. 16 bar (polycarbonate bowl), Max. 20 bar (metal bowl)
Температура окружающей среды	Max. 50 °C (polycarbonate bowl), Max. 80 °C (metal bowl)
Температура среды	max. 50 °C
Уплотнение	Нитрильный каучук
Размер пор в фильтрующем элементе	40 µm
Мембрана	NBR
Капельная насадка	PA
Корпус	Die-cast zinc
Пружинная крышка	POM
Drain valve	Manual
Измерение расхода воздуха	At P1 = 10 bar, P2 = 6 bar and pressure drop $\Delta p = 1$ bar
Дополнительная информация	Wartungseinheiten sind auch mit Schutzkorb oder Metallbehälter lieferbar. Wartungseinheiten sind auch in anderen Regelbereichen lieferbar.

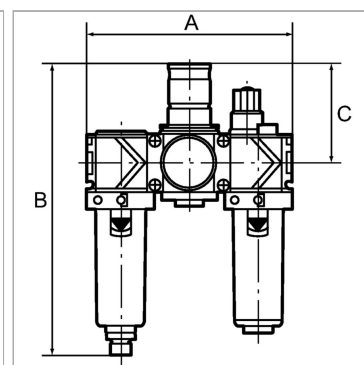

Информация о продукте

Резьба	G 3/4
Диапазон регулирования	0.5 - 10 bar
Расход пот.	5000 l/min

C	98 mm
A	210 mm
B	247,0 mm

Указания

Прочие данные только по запросу.

Описание

Two or three-piece service units consisting of a reversible diaphragm pressure regulator, independent of inlet pressure, with self-relieving design, combined with a centrifugal separator and a proportional lubricator. Approved series in modern industrial design, with the following key benefits: Simple handling, Convenient modular assembly thanks to innovative fasteners, Excellent flow values.

Указание по заказу

Service units are also available with bowl guard or metal bowl. Service units are also available in other control ranges (0.5 - 6 bar and 0.5 - 16 bar) and in lockable version. Please ask for more information.

Дополнительная информация

Service units are also available with bowl guard or metal bowl. Service units are also available in other control ranges.