

### Характеристики

<b>Входное давление</b>	Max. 16 bar (polycarbonate bowl), Max. 20 bar (metal bowl)
<b>Температура среды</b>	max. 50 °C
<b>Температура окружающей среды</b>	Max. 50 °C (polycarbonate bowl), Max. 80 °C (metal bowl)
<b>Уплотнение</b>	Нитрильный каучук
<b>Размер пор в фильтрующем элементе</b>	40 µm
<b>Мембрана</b>	NBR
<b>Капельная насадка</b>	PA
<b>Корпус</b>	Die-cast zinc
<b>Пружинная крышка</b>	POM
<b>Drain valve</b>	Manual
<b>Измерение расхода воздуха</b>	At P1 = 10 bar, P2 = 6 bar and pressure drop $\Delta p = 1$ bar
<b>Дополнительная информация</b>	Wartungseinheiten sind auch mit Schutzkorb oder Metallbehälter lieferbar. Wartungseinheiten sind auch in anderen Regelbereichen lieferbar.

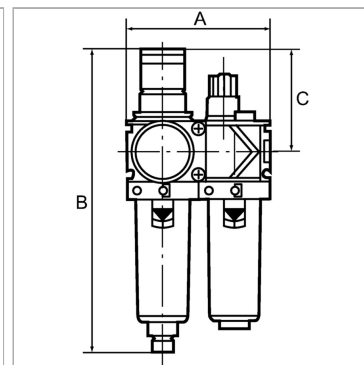

### Информация о продукте

<b>Резьба</b>	G 1/4
<b>Диапазон регулирования</b>	0.5 - 10 bar
<b>Расход пот.</b>	1500 l/min

<b>C</b>	68 mm
<b>A</b>	96 mm
<b>B</b>	203,0 mm

### Указания

Прочие данные только по запросу.

### Описание

Two or three-piece service units consisting of a reversible diaphragm pressure regulator, independent of inlet pressure, with self-relieving design, combined with a centrifugal separator and a proportional lubricator. Approved series in modern industrial design, with the following key benefits: Simple handling, Convenient modular assembly thanks to innovative fasteners, Excellent flow values.

### Указание по заказу

Service units are also available with bowl guard or metal bowl. Service units are also available in other control ranges (0.5 - 6 bar and 0.5 - 16 bar) and in lockable version. Please ask for more information.

### Дополнительная информация

Service units are also available with bowl guard or metal bowl. Service units are also available in other control ranges.