

Precision pressure regulators with continuous pressure supply

Обновлено: 04.24.24

Характеристики

Входное давление	Max. 16 bar
Область температур	-10 °C to +50 °C
Рабочие среды	Сжатый воздух
Мембрана	NBR
Соединительная резьба	Material: Die-cast zinc
Корпус	Material: Grivory® (PA 66)
Расход собственного воздуха	2.6 l/min at P2 = 6 bar (depending on secondary pressure)
Измерение расхода воздуха	At P1 = 10 bar, P2 = 6.3 bar and pressure drop $\Delta p = 1$ bar

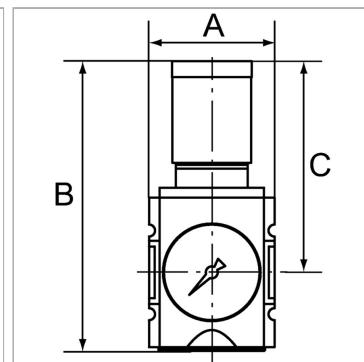

Информация о продукте

Резьба	G 3/8
Диапазон регулирования	0.1 - 1 bar
Расход пот.	2700 l/min

C	95.5 mm
A	52 mm
B	128,5 mm

Указания

Прочие данные только по запросу.

Описание

Precision diaphragm pressure regulators with self-relieving design and excellent flow rates in modern design for mounting side by side.

By assembling two or more controllers together, it is possible to supply several working air circuits with different pressures via a single supply line.

Указание по заказу

The price does not include a key lock. Please order separately.