

### Характеристики

<b>Входное давление</b>	Max. 60 bar
<b>Применение</b>	Compressed air and other neutral, non-flammable gases
<b>Рабочая температура</b>	-10 °C to +90 °C
<b>Уплотнение</b>	Нитрильный каучук
<b>Материал</b>	Латунь
<b>Измерение расхода воздуха</b>	At P1 = 20 bar, P2 = 10 bar and pressure drop $\Delta p = 4$ bar

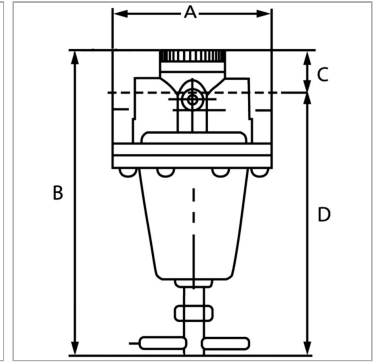

### Информация о продукте

<b>Резьба</b>	G 1
<b>Диапазон регулирования</b>	3 - 50 bar
<b>Расход пот.</b>	5000 l/min
<b>C</b>	51 mm

<b>C</b>	51 mm
<b>A</b>	118 mm
<b>B</b>	257,0 mm
<b>D</b>	206 mm

### Указания

Прочие данные только по запросу.

### Описание

Reversible piston-type pressure regulator, virtually independent of inlet pressure, with self-relieving design, manufactured entirely in brass. Specially designed for high pressures up to 60 bar. Pressure catch with counter nut.